

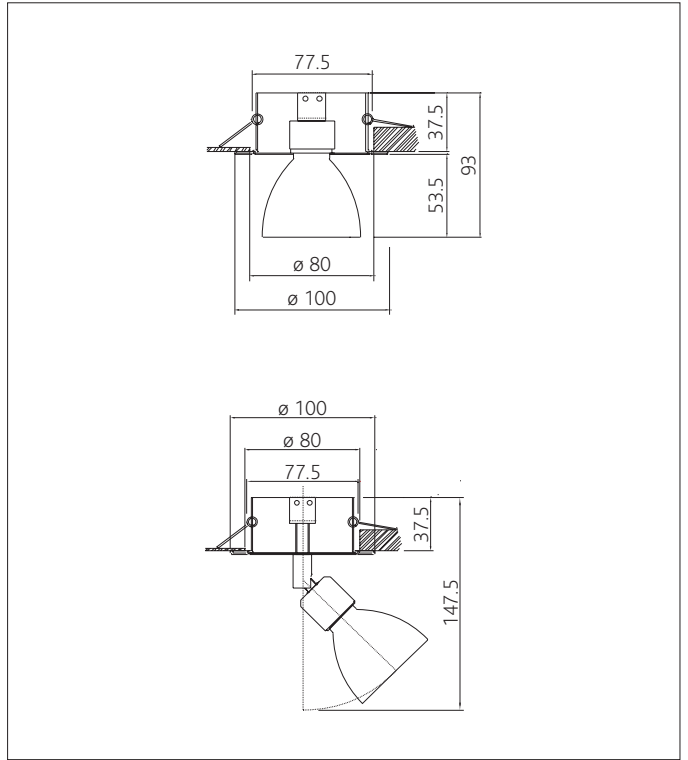











SPOTS



TABEA			
Einbauspot			
Empfohlenes Leuchtmittel: Halogen Niedervolt, max. 50 W, 12 V, Stiftsockel GY6.35			
Einbautiefe:	40 mm		
Deckenstärke:	1 – 15 mm		
Deckenausschnitt:	Ø 80 mm		
     			
A.9950	NR 120 200	Einbaugehäuse ohne Dreh-Kippgelenk	teiltransparent
A.9950	NR 120 201	Einbaugehäuse ohne Dreh-Kippgelenk	satiniert
A.9950	NR 120 500	Einbaugehäuse mit Dreh-Kippgelenk	teiltransparent
A.9950	NR 120 501	Einbaugehäuse mit Dreh-Kippgelenk	satiniert

TABEA			
Recessed spot			
Recommended lamp: halogen, low-voltage, max. 50 W, 12 V, pin base GY6.35			
Depth of insertion:	40 mm		
Ceiling thickness:	1 – 15 mm		
Ceiling opening:	Ø 80 mm		
     			
A.9950	NR 120 200	Recessed housing without swivel and tilt joint	translucent
A.9950	NR 120 201	Recessed housing without swivel and tilt joint	satined
A.9950	NR 120 500	Recessed housing with swivel and tilt joint	translucent
A.9950	NR 120 501	Recessed housing with swivel and tilt joint	satined

NOTIZEN/NOTES
